

Product data

Product code	VC05-0036	STK-code	1914132	EAN-code	6410019141320
Product name	OTL-connector 1xAl/Cu 240mm² (Yellow/Green)				
Wires	1xAl/Cu 240mm²				

Technical data

Nominal current	Cu	425	A
	Al	380	A
Nominal voltage		690	V
Max. Current (US)	Cu	-	A
	Al	-	A
Max. Voltage (US)		-	V
Number of pole		1	pcs
Max. Cross section		240	mm ²
Tightening torque	35-120 mm ²	26	Nm
	150-240 mm ²	40	Nm
		-	Nm
		-	Nm
Max. Operating temperature		80	°C
Weight		195	g
IP-protection		IP20	
Standards	EN 61238-1; EN60947-7-1		
Color/ Material	Green RAL 6018, Yellow RAL 1016/ PA66		
Mounting/ Connection	DIN-rail and screw (M5) mounting		

Description

OTL-connectors are designed to be used connecting and branching aluminium and copper conductors. Bodies are made of tin-plated aluminium.

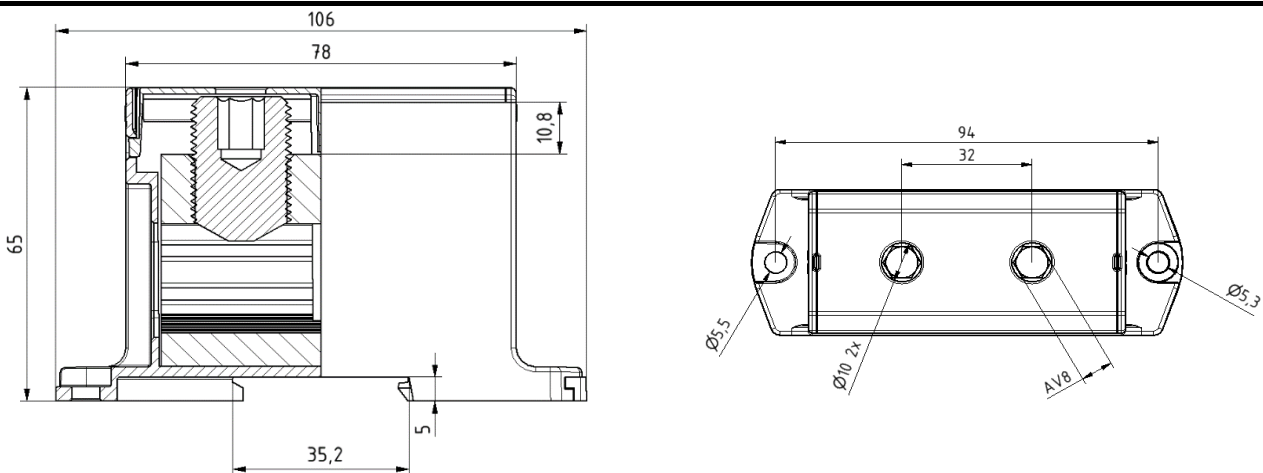
Drawing

Package

Package	Box	pcs/ package	3	Weight [Kg]	0,60
Length [mm]	120	Width [mm]	130	Height [mm]	100