

Product data

Product code	VB04-0003	STK-code	5216442	EAN-code	6410052164423
Product name	Shear bolt splice connector ORJA 95-120				
Wires	Al 95-120 mm ²				

Technical data

Nominal current	Cu	-	A
	Al	-	A
Nominal voltage		1000	V
Number of pole		1	pcs
Max. Cross section		120	mm ²
Tightening torque	95-120 mm ²	21-27	Nm
	-	-	
	-	-	
	-	-	
Max. Operating temperature		-	°C
Weight		106	g
IP-protection		-	
Standards	SFS 2663:1975		
Material/ Coating	Aluminium, no coating		
Mounting/ Connection	Shear head screws		



Description

ORJA, Shear bolt splice connector are suitable for aluminium conductors. Solid, stranded, sector shaped and circular conductors are allowed. The installation is made by shear head screws and torque tools are not needed.

Drawing

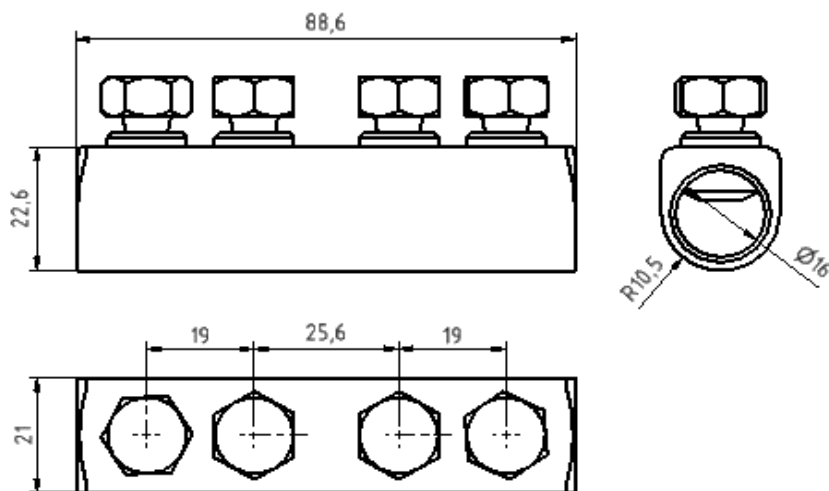

Package

Package	Bag	pcs/ package	3	Weight [Kg]	0,32
Length [mm]	-	Width [mm]	-	Height [mm]	-